

DeltaV™ Smart Switches

- Completely managed by DeltaV systems
- Network alerts and diagnostics automatically reported to DeltaV workstations
- Can be installed on the network between the DeltaV workstations and the Emerson Smart Firewall (DeltaV 2.5 network)
- Plug-and-play installation
- Auto security lockdown
- A full line of Industrial Rated Fanless Switches
- Fully supported by Emerson



DeltaV Switches provide plug-and-play industrial switches with enhanced security features.

Introduction

The DeltaV™ Network “Smart” switches are the next generation in the use of commercial off-the-shelf (COTS) components in control systems. Called “purpose-built” commercial components, these switches combine the lower cost of off-the-shelf components with DeltaV specific software and features to make them more integrated and plug-and-play in the DeltaV Area Control Network (ACN) and other DeltaV networks external to the ACN.

DeltaV Smart Switches require no configuration to function in the DeltaV networks. Accessing the advanced features takes only minor configuration that is easy to perform using the DeltaV Network Device Command Center and secured so you can’t incorrectly configure any switching functions that impact the performance of the DeltaV system.

This purpose-built switch allows the DeltaV system to provide an auto port lockdown advanced security feature that is easy for a control system user to implement: an increasingly important product feature in today’s hostile environment.

Benefits

Completely Managed by DeltaV. Power up the switch and it is automatically discovered by the DeltaV switch commissioning application in the Network Device Command Center (formerly the Smart Switch Command Center). The network address is automatically assigned by DeltaV DCS or by the user when installed in the DeltaV 2.5 network (new in DeltaV v13.3). Just provide a switch name, description, and select a few setup parameters and the switch begins reporting. *No more serial connections are required to configure switches.*

Network alerts and diagnostics automatically reported to DeltaV workstations. Operators and maintenance stations will automatically receive device alerts indicating network communications irregularities. The DeltaV Network Device Command Center application provides the interface to diagnose and troubleshoot network problems. *All built-in without the need for third party applications for network monitoring.*

Plug-and-play installation. Smart Switches are configured with DeltaV-compatible settings so that they can be installed into a compatible DeltaV network right out of the box. They require no user configuration to fully support DeltaV network communications. There is no user access to make changes to this default switching configuration so you never have to worry about a misconfigured switch impacting network performance. Plug and play requires any existing switches or network devices to be configured to communicate in 100/1000 full duplex or to auto-negotiate. See the compatibility sections in this document for details.

Auto lockdown prevents unauthorized network connections. Disabling unused network connections is a security “best practice” and helps you comply with plant security policies. With the one-click lockdown capability built into the switch, you can automatically lock all unused network ports in the system with a single button click in the DeltaV Network Device Command Center application. *Easy to secure the network from intrusions.*

Full range of switch hardware configurations. DeltaV network switches are available in a variety of hardware solutions. From a 24-port rack-mounted unit to both fixed-port and modular field-mounted switches, the DeltaV network switch will meet a wide variety of network requirements. *The broad line of DeltaV Smart Switches are all you need to implement a complete DeltaV control network.*

Fully supported by Emerson. As Emerson products, these DeltaV Network Switches are completely supported by Emerson when used within the DeltaV network. You receive full technical support from our Global Service Center, warranty support, product support, and education—all from Emerson.

Product Description

The DeltaV network “smart” switch is a Fast-Ethernet Layer 2 network switching device. The switch is available in three variations.



The VE6046, VE6047, VE6048 and VE6053 DeltaV Smart Switches: 19” rack-mountable 8, 16, or 24 ports modular switch with wired and fiber connections and two gigabit wired or fiber uplinks (all ports in the VE6053 switch are gigabit).



The VE6041 DeltaV Smart Switch: a DIN rail eight ports 10/100 Mbps switch with fiber and wire uplinks. Available in standard and extended temperature/ conformal coated versions.



The VE6042 and VE6043 DeltaV Smart Switch: a DIN rail-mounted modular switch supporting e8, 16, or 24 ports using wired and fiber communication modules. The VE6043 provides two gigabit wired or fiber uplinks in addition to the twenty-four local ports. Available in standard and extended temperature/conformal coated versions.

Typical Network Examples using DeltaV Smart Switches

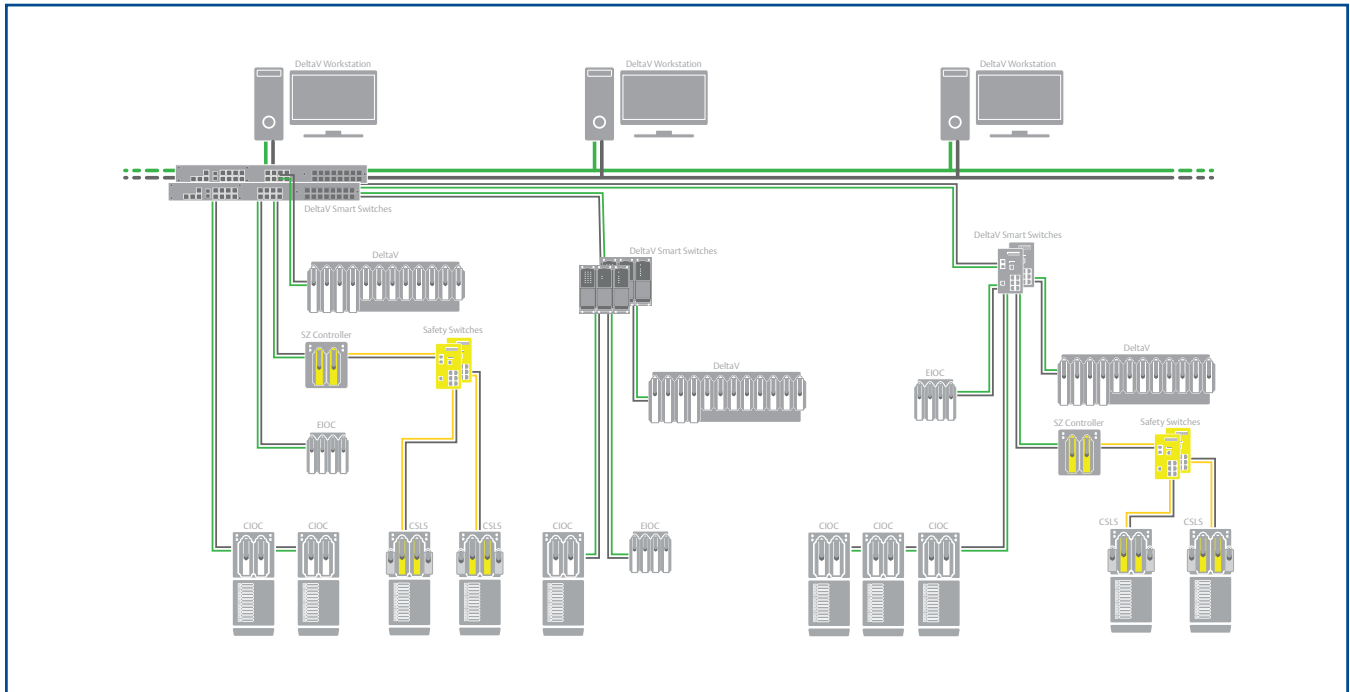

Typical network implementation would use the VE6048 as a central switch located in a rack room where AC power is available with the VE6041 (or VE6042 or VE6043) as a field-mounted switch for controllers in field-mounted locations. If required as part of the network architecture, multiple VE6048 switches can be interconnected using the gigabit ports to provide a network backbone to connect devices or other DeltaV switches. The VE6053 can also be used as a central switch when all gigabit ports are required.

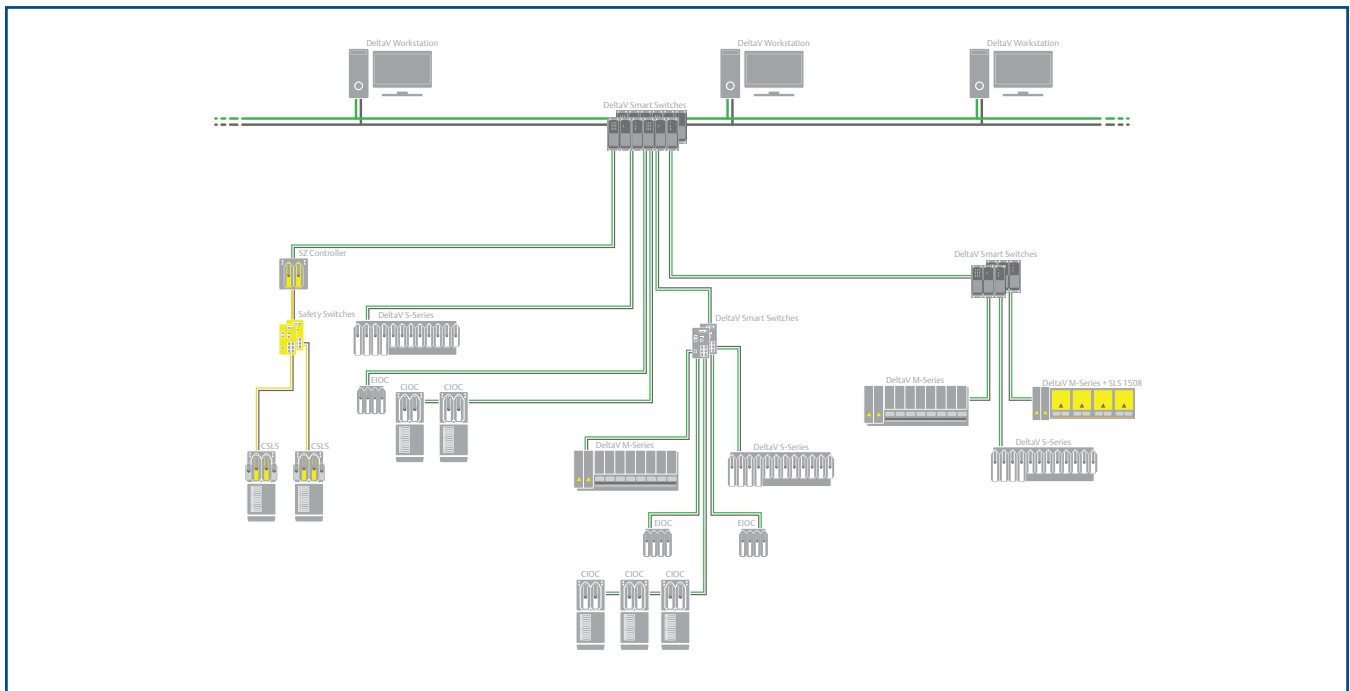

The VE6042 or VE6043 can also be used as a central switch if a more modular switch solution is required or to meet extended environment specifications due to the location of the central switch.

Starting in v13.3 the DeltaV Smart Switches can be installed in the DeltaV 2.5 network (and other DeltaV networks external to the DeltaV control network) and managed from the DeltaV Operator Workstation using the DeltaV Network Device Command Center. In this network the Smart Switch is managed only by the DeltaV Network Device Command Center as it is in the DeltaV ACN. The Smart Switch is not user configurable except what is available through the DeltaV Network Device Command Center.

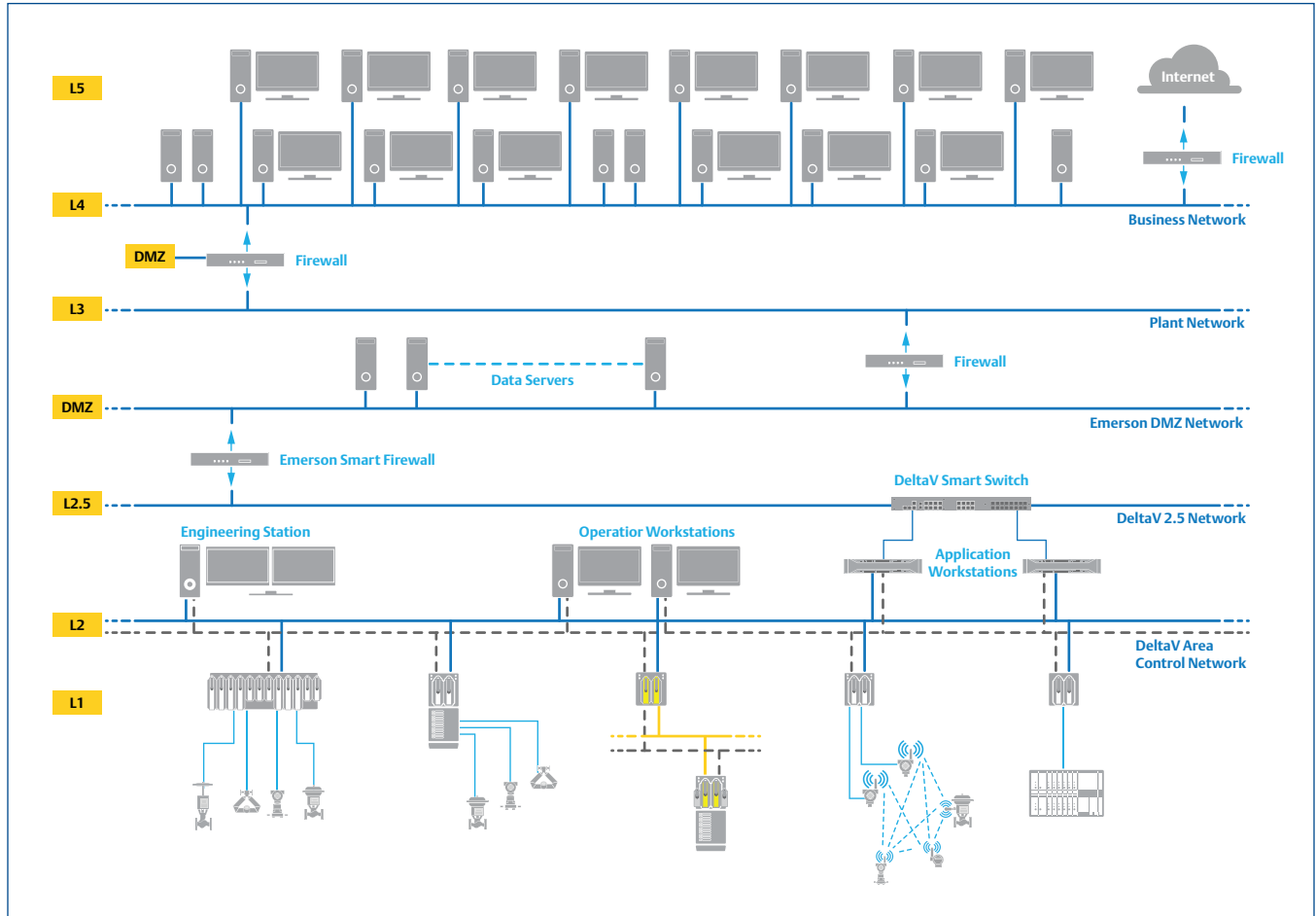

DeltaV reference architecture showing network segmentation and use of DeltaV Smart Switches in the L2.5 network.

When the Smart Switch is installed in the network between the DeltaV workstations and the Emerson Smart Firewall or (other perimeter firewall) it can be locked down to protect this network from unauthorized network connections.

DeltaV Network Device Command Center

The DeltaV Network Device Command Center is a DeltaV application that provides full integration of the DeltaV Smart Switches into the DeltaV and the DeltaV 2.5 networks. The Command Center is used to perform switch commissioning to create the communication between the DeltaV network and the switch management application. The Network Device Command Center provides access to the switch and network diagnostics, device alert details, and port lockdown applications. The management application provides a centralized application to commission, diagnose, troubleshoot, and secure the DeltaV Smart Switches. The Command Center can be viewed by any DeltaV user.

The ability to commission and lock switches is limited to the Can Configure, Can Calibrate, and Can Download user privileges. Starting in DeltaV v13.3 the DeltaV Smart Switch can be installed in the DeltaV 2.5 network or other DeltaV networks external to the DeltaV control network. For the DeltaV Smart Switch to be installed in a network the switch must be connected to a DeltaV workstation (for example, Professional Plus) running control modules.

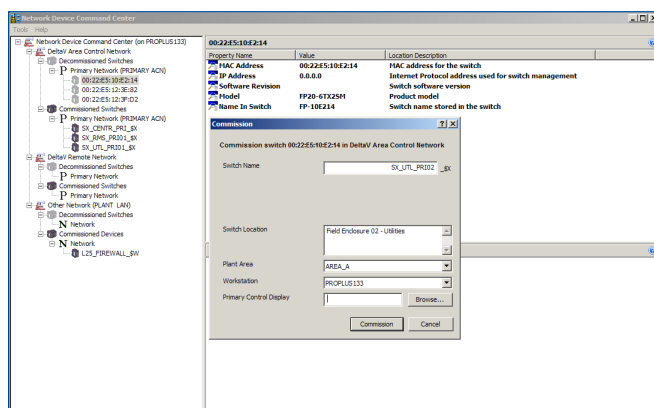

The Network Device Command Center switch commissioning will automatically assign a network address to the switch so the switch can send PlantWeb alerts to DeltaV workstations.

DeltaV Plug-and-Play Installation

The DeltaV switches are easy to install in your DeltaV network. Since they come preconfigured from the factory, installation is as simple as mounting the unit, connecting the communications cables, and powering up the unit. The switch is configured to begin communications on power up — no additional setup is required for the switching function to work properly. This *immediately returns the system to full redundancy capability as quickly as possible with no time wasted configuring the switch prior to installation.*

Smart Switch Commissioning

Commissioning is done from a DeltaV workstation after the switch is placed in service. Commissioning the switches after they are installed creates the interface between DeltaV and the switch that gains the full benefit of using the Smart Switch. Commissioning allows the advanced switch setup parameters in the switch to be preconfigured so they only have to be entered once for the system. These parameters only have to be changed if the default settings need to be modified.

Once the commissioning process assigns a network address to the switch it will automatically begin reporting PlantWeb alerts to the workstations. It also allows the Network Device Command Center access to network diagnostics and the one click lockdown security application. *Integration into the DeltaV system eliminates the pre-installation configuration and gets your system back to full strength as quickly as possible.*

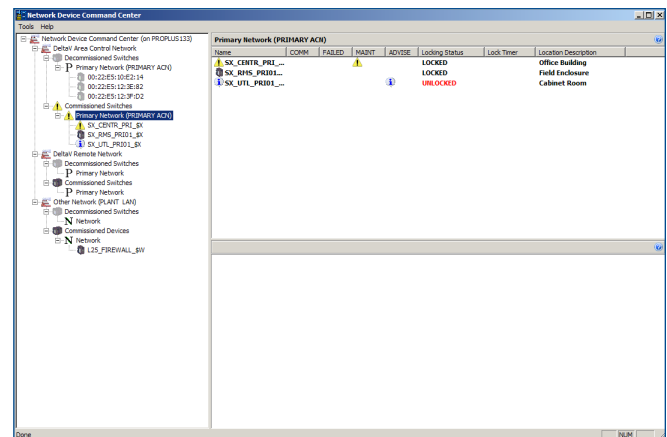

The Network Device Command Center provides an overview of the switch status information including any device or network alerts and the switch security lockdown status.

Switch and Network Status Alerts

Using standard DeltaV device status reporting the DeltaV Smart Switches will automatically report the status of both the switch health and network communications problems. Reporting items such as switch communications failure, switch temperature, and power supply status. In addition the status of network communications such as excessive packet collisions or excessive dropped packets indicative of network problems the DeltaV system provides all the network status information without the use of third party SNMP applications.

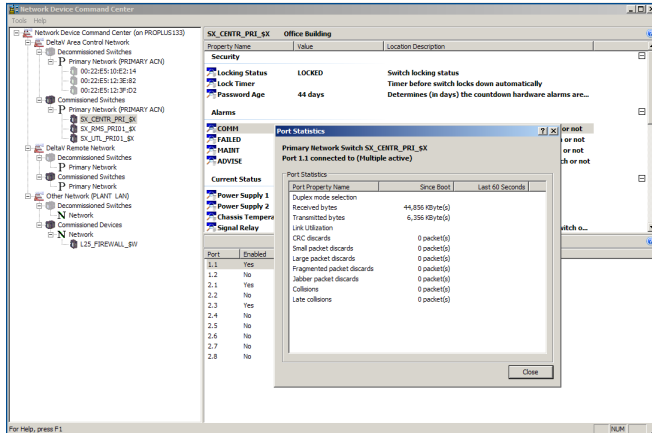

Detailed DeltaV network diagnostics are at your fingertips without the need for 3rd party SNMP applications.

Security Event Reporting DeltaV Smart Switches will report security related events such as high network traffic that indicate a denial of service attack is present and a port locking violation that indicates an unauthorized device has been connected to a “locked” switch port. Users are notified immediately that a security event has occurred and can take actions to mitigate the attack.

Network Diagnostic Information The Network Device Command Center provides detailed network statistics to help in diagnosing network problems. Information is available on a port-by-port basis so problem communications can be easily isolated. The parameters most commonly used in troubleshooting network issues such as dropped packets are consolidated on a single display and *the information needed is right at your fingertips so troubleshooting the DeltaV network is easy.*

Auto Security Lockdown

The DeltaV Smart Switches contain auto lockdown security technology to prevent unauthorized access to the network. The DeltaV Network Device Command Center will automatically locate all of the Smart Switches in the network and display their locked or unlocked status. From the Command Center a privileged user can lock or unlock all the switches in the network with a single click. Or they can select a single

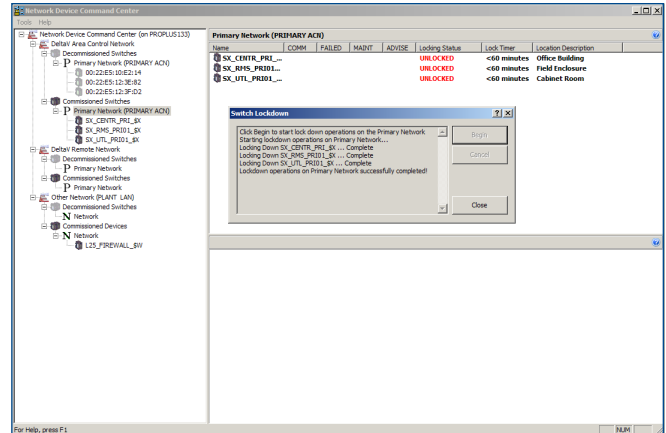

A single click will lock and unlock the switches for maintenance and to add new devices. In addition the optional lockdown timer will automatically relock switches in 60 minutes to prevent accidentally leaving the switches in an insecure state.

switch or set of switches to lock or unlock.

The “lock” command tells the switch to find all of the unused network ports and disable them. It will also memorize what devices are connected on each local port to prevent an existing device from being replaced by an unauthorized rogue device.

Another single click will command all the switches to “unlock,” to add a new device, or to troubleshoot any network problems. The optional 60-minute relock timer will automatically relock all of the switches to prevent the devices from accidentally being left in the insecure, unlocked state.

The Command Center can be run from just the ProfessionalPlus or can also be installed on operator or maintenance stations for easy user access.

All locking and unlocking events are logged in the DeltaV Event Journal so you can easily monitor unlocking events for unusual activity and to be sure proper security procedures are being followed.

System Compatibility

Network Storm Protection Features

Packet rate limiting - the Smart Switch is configured with a fixed rate packet limiting setting. The switch rate limiting prevents network communication storms generated from broadcast, multicast, and unknown unicast messages from impacting DeltaV communications by blocking excessive traffic. These types of excess traffic can occur naturally as part of the traffic generated by Ethernet communications. Storm protection is enabled to protect the network during system maintenance activities, redundancy switchovers, and during times when the system is performing routine network activities where excess network traffic is possible.

Network Loop protection – spanning tree protocol is implemented on the Smart Switch to prevent a network loop from creating a network communication storm.

These storm protection features are enabled by default and cannot be disabled or configured. Storm protection is enabled even if the switch is not given an IP address for management.

These features are completely compatible with older DeltaV Smart Switches. Existing switches can be field upgraded to use these new features if desired.

Please see the general specifications section for specific firmware version numbers.

Important note: Network storm protection and loop protection are available only on managed switches. Therefore, DeltaV control networks using Electronic Marshalling require a Smart Switch installed between the DeltaV controller and CIOC. This network configuration reduces the risk of a network storm disrupting communications and causing the CIOC to go to a fail-safe mode.

Please refer to DeltaV Books-On-Line and the v13.3 System Planning Guide for more information and requirements for implementing the DeltaV Area Control Network with Electronic Marshalling.

Compatible with previous versions of DeltaV systems

Switches are compatible with existing systems that are installed using only our supported Cisco or Hirschmann switches. Fiber communications of the Smart Switch will only communicate at 100/1000MB full duplex (not configurable) and wired ports will only auto-negotiate communications (setting is not user adjustable).

Existing switches must be configured to run either in auto-negotiate mode or 100/1000MB full duplex communications.

Existing 3COM switches and media converters may not be compatible with the DeltaV Smart Switch as they may not support the required communications. The Smart Switch will not plug and play in some older networks unless the existing devices are set to match the specifications above during the installation.

The auto switch lockdown is compatible only with DeltaV v10.3 and later revisions.

Compatible with non-DeltaV Switches

The DeltaV Smart Switch also can be installed in a new system mixed with the currently supported and shipping Cisco or Hirschmann switches.

Please read DeltaV Books-on-line for important information when retrofitting into existing DeltaV networks, especially in systems with existing 3COM switches or media converters.

Fiberoptic connections on DeltaV Smart Switches are non-configurable and communicate only at 100Mbps on the DeltaV ACN or 1Gbps switch-to-switch at full duplex.

Installing DeltaV Smart Switches into systems with existing fiberoptic devices that are not set to 100/1000Mbps full duplex will cause communications disruptions in the network.

Use outside of the DeltaV Control Network

The DeltaV Smart Switches is supported only as an unmanaged switch if installed in networks outside of the DeltaV control network, the DeltaV 2.5 network between the DeltaV workstations and the perimeter firewall (such as the Emerson Smart Firewall), or other DeltaV networks external to the DeltaV control network. The switch will only accept a management port network address from the DeltaV Network Device Command Center and the switch can only be used where this application is able to access the switch.

The DeltaV Smart Switches is not available for use as a managed switch in the DeltaV InterZone network as the DeltaV Network Device Command Center cannot access the switch if located on this network.

Table 1 - DeltaV Smart Switches Network Compatibility

DeltaV ACN	Yes
DeltaV 2.5 network	Yes*
DeltaV Remote Network (DeltaV RAS)	Yes*
DeltaV virtualization thin client network	Yes*
DeltaV virtualization host server domain controller network	No
DeltaV Inter-Zone network	No
Plant DMZ and other networks not connected directly to a DeltaV workstation	No

*DeltaV v13.3 and later only requires this network have access to a DeltaV workstation running control modules.

Product Specifications

The DeltaV Smart Switches is based on hardware produced by a recognized supplier of industrial-grade networking equipment. All switches are fan-less and have redundant power connections. Some models are also available in high temperature, conformal coated versions for use in harsh environments. The firmware features are identical in all models of the DeltaV Smart Switch.

The DeltaV Smart Switches are preconfigured for use exclusively within the DeltaV control network or the networks listed in Table 1 above. All switch configuration is performed using the DeltaV Network Device Command Center [for DeltaV 10.3 configuration is only done through the DeltaV Setup Wizard using the serial port Command Line Interface]. These configuration interfaces provide very limited access to switch configuration parameters. General administrator access to the DeltaV Smart Switches is disabled to prevent possible mis-configuration of the switch that would impact DeltaV network performance. A list of the available configuration parameters is listed in the DeltaV Setup Parameter section of these specifications.

In DeltaV v13.3 and later the DeltaV Smart Switches can be installed in the DeltaV 2.5 network or other DeltaV networks external to the DeltaV control network (see Table 1). For the DeltaV Smart Switches to be installed in a network, the switches must be connected to a DeltaV workstation running control modules. It can be installed in the DeltaV virtualization networks only if the network is accessible to a DeltaV workstation (virtual or physical) running control modules. These specific control modules are required to run the DeltaV Network Device Command Center application. DeltaV Operator Workstations are not capable of running these control modules.

Fiberoptic Cable specifications – apply to all switch models

Fiberoptic Cable Types	Specifications Specifications apply to all fiber connections on any model of DeltaV Smart Switch <i>Actual fiberoptic distances achieved depend on the fiber type used and other components installed on the network such as splices and patch panels that can reduce fiberoptic signal strength.</i>
Multimode Fiber (Mm) 50/125 μm	0 - 5000 m, 8 dB link budget at 1300 nm, A = 1 d/km, 3 dB reserve, B = 800 MHz·km
Multimode Fiber (Mm) 62.5/125 μm	0 - 4000 m, 11 dB link budget at 1300 nm, A = 1 dB/km, 3 dB reserve, B = 500MHz·km
Single Mode Fiber (Sm) 9/125 μm	0 – 32.5 km, 16 dB link budget at 1300 nm, A = 0.4dB/km, 3 dB reserve, D = 3.5 ps/(nm·km)
Single Mode Fiber (Lh) 9/125 μm (Long Haul Transceiver):	24 – 86.6 km, 7 - 29 dB link budget at 1550 nm, A = 0.3dB/km, 3 dB reserve, D = 19 ps/(nm·km)

General Specifications for all DeltaV Smart Switches

General Specifications for all DeltaV Smart Switches	
All switches are Fast ETHERNET – Wire Speed Layer 2 Smart Switch with store-and-forward-switching, Industrial switch fan-less design.	
User Access <i>Note: The DeltaV Smart Switches is pre-configured and do not provide any general administrator access to switching configuration parameters.</i>	Configuration Access: All switch configurations are performed using the DeltaV Network Management Center applications or using the DeltaV Setup Wizard through the serial port. There is no general access to the switch configuration. Read-only Access: Network Device Command Center device and network diagnostic information: Advanced diagnostics are available using the serial interface or view-only web interface. DeltaV Smart Switches can interface to an SNMP application using view-only SNMP v3 communications.
Network Storm Protection	Packet rate limiting enabled with fixed rate settings, Network Loop protection: Requires Switch firmware versions: v4.2.11 for all DeltaV Smart Switches portfolios (there are specific firmware files per switch model type).
Diagnostics	Front panel LEDs, signal contact in addition to DeltaV Network Device Command Center: DeltaV Smart Switches also support internal log-files and syslog servers.
Setup	No setup is required for switching functions. DeltaV Network Device Command Center application is for diagnostic and alerts.
Security	DeltaV Auto port lockdown, view-only Network Device Command Center for monitoring: All user access is authenticated using local DeltaV user passwords.
Redundancy	Standard DeltaV network redundancy.
Real-Time	Real-time clock–supports NTS as a client.

Ambient Conditions	VE6041, VE6042, VE6043, VE6045 DIN rail mounted Standard Model ending in C1	VE6041, VE6042, VE6043, VE6045 DIN rail mounted Extended Specs model ending in C2	VE6046, VE6047, VE6048, VE6053 Rack Mount switches and VE6049 media modules
Operating Temperature	0° to +60°C	-40° to +70°C	0° to +50°C
Storage/Transport Temperature	-40° to +70°C	-40° to +70°C	-20° to +85°C
Relative Humidity (Non-Condensing)	10% to 95%	10% to 95%	10% to 95%
Conformal-Coated	No	Yes	No
Harsh Area Rating	G2	G2 (conformal coating allows switch to be used in G3 environments but switch is not certified to G3)	G2
<p>Mechanical stability – All switches except as noted: IEC 60068-2-27 shock 15 g, 11 ms duration, 18 shocks IEC 60068-2-6 vibration 1 mm, 2 Hz - 13.2 Hz, 90 min.; 0.7g, 13.2 Hz - 100 Hz, 90 min.; 3.5 mm, 3 Hz – 9 Hz, 10 cycles, 1 octave/min.; 1g, 9 Hz - 150 Hz, 10 cycles, 1 octave/min. VE6053: IEC 60068-2-6 3.5 mm, 5–8.4 Hz, 10 cycles, 1 octave/min; 1 g, 8.4–150 Hz, 10 cycles, 1 octave/min</p> <p>EMC emitted immunity FCC CFR47 Part 15 Class A EN 55022 EN 55022 Class A</p> <p>EMC interference immunity VE6041, VE6042, VE6043, and VE6045 DIN rail switches: EN 61000-4-2 electrostatic discharge (ESD) 6 kV contact discharge, 8 kV air discharge EN 61000-4-3 electromagnetic field 10 V/m (80 - 1000 MHz) EN 61000-4-4 fast transients (burst) 2 kV power line, 1 kV data line EN 61000-4-5 surge voltage power line: 2 kV (line/earth), 1 kV (line/line), 1kV data line EN 61000-4-6 conducted immunity 3 V (10 kHz - 150 kHz), 10 V (150 kHz - 80 MHz)</p> <p>EMC interference immunity: VE6046, VE6047, VE6048, and VE6053 Rack mount Switches EN 61000-4-2 electrostatic discharge (ESD) 4 kV contact discharge, 8 kV air discharge EN 61000-4-3 electromagnetic field 10 V/m (80 - 2700 MHz for all models except for the VE6053, which supports 80 - 3000 MHz) EN 61000-4-4 fast transients (burst) 2 kV power line, 4 kV data line EN 61000-4-5 surge voltage power line: 2 kV (line/earth), 1 kV (line/line), 4 kV data line EN 61000-4-6 conducted immunity 10 V (150 kHz - 80 MHz)</p>			

General Specifications for the VE6041 DeltaV Smart Switches

Power requirements

Operating voltage: 24 VDC (18-30 V)

Mechanical construction

Dimensions (W x H x D): 74 x 131 x 111 mm (2.91 x 5.16 x 4.37 in)

Mounting: DIN Rail

Weight: 410 g (14.48 oz) – all models

Protection class: IP20

Interfaces

Power supply/signaling contact plug-in terminal block (max. 1 A, 24 V DC / 24 V AC)

V.24 interface RJ11 socket for serial cable connection for DeltaV Setup Wizard access

USB interface for flash upgrades

Provided in VE#

One VE6041 switch with terminal block

NOTE: These switches are described as supporting local ports and uplink ports. Local ports are connected to a single device such as a controller or workstation. An uplink port is connected to another switch. There is no difference in the way the ports function, and a port designated as an “uplink port” can be used as a local port.



General Specifications for the VE6042 and VE6043 DeltaV Smart Switches

Power requirements

Operating voltage 24 VDC (18-32 V)

Mechanical construction

Dimensions: varies by model (see order information section)

Mounting: DIN Rail

Weight: varies by model (see order information section)

Protection class: IP20

Interfaces

Power supply/signaling contact plug-in terminal block (max. 1 A, 24 V DC / 24 V AC)

V.24 interface RJ11 socket for serial cable connection for DeltaV Setup Wizard access

USB interface for flash upgrades

Provided in VE#

One VE6042 or one VE6043 switch with terminal block

NOTE: The VE6042 and VE6043 use an active backplane—the switching functions of the switch are contained in the backplane. The switch module contains the power supply and power and serial interface connections. The switch is composed of these two units and is available only as the complete switch unit.



General Specifications for the VE6046, VE6047, and VE6048 DeltaV Smart Switches

Up to 26 ports Fast Ethernet/Gigabit Ethernet Industrial Workgroup Switch.



Ports available:

Base module has 10 ports: two uplink ports (10/100/1000 Mbps copper / SFP ports – VE6050 transceiver modules compatible) and eight 10/100 Mbps copper ports in a fixed configuration.

The VE6048 switch supports expansion media modules (VE6049) that can add up to sixteen 10/100 Mbps extra ports. Each media module has eight ports including copper, fiber or SFP ports.

The VE6046 and VE6047 are not modular switches and are fixed at twenty-four 10/100 Mbps copper ports and eight 10/100 Mbps copper ports respectively. Both switches have two additional 10/100/1000 Mbps uplink copper / SFP ports.

Power requirements

Operating voltage: 100 - 240 VAC, 47 - 63 Hz

Rated Current 0.2 – 0.4 A

Mechanical construction

Dimensions (W x H x D): 448 x 310 x 44 mm (17.64 x 12.20 x 1.73 in) – without mounting bracket

Mounting: 19" control cabinet

Weight: 3.60 kg

Protection class: IP20

Interfaces

Power supply/signaling contact plug-in terminal block (max. 1 A, 24 V DC / 24 V AC)

V.24 interface RJ11 socket for serial cable connection for DeltaV Setup Wizard access





USB interface for flash upgrades

Provided in VE#

One VE6046 or one VE6047 or one VE6048 switch with terminal block for signal contact, two brackets with fastening screws (pre-assembled), housing feet - stick-on, and power cable.

NOTES:

- Expansion modules, Fast Ethernet SFP modules, Gigabit Ethernet SFP modules and serial cable must be ordered separately
- When rail mounted, these switches require mounting supports in addition to 10" rail mounting brackets
- All copper ports can be connected using twisted pair cables with up to 100 meters of length
- The built-in SFP module ports for these switches support any combination of VE6050 transceiver modules
- The VE6050 gigabit transceiver modules are not compatible with VE6049 expansion modules
- VE6046, VE6047, and VE6048 switches do not support stacking. To create a central switch of greater than 24 ports, switches should be interconnected using the front panel (built-in) gigabit ports.

Specifications for VE6049 Expansion Modules				
	 Specifications for VE6049M01	 Specifications for VE6049M02	 Specifications for VE6049M03	 Specifications for VE6049M04
Length of cable	100 m (max.)	See fiber cable specs	See fiber cable specs	See fiber cable specs
Power Requirements:				including SFP modules
Current consumption	2 W	10 W	10 W	11 W
Power output in BTU (IT) h	7	7	7	7
Mechanical Constructions:				
Dimensions MM (W x H x D)	138 x 90 x 42mm	138 x 90 x 42mm	138 x 90 x 42mm	138 x 90 x 42 mm
Weight	0.21 Kg	0.18 Kg	0.18 Kg	0.13 Kg (excludes SFP modules)
Protection class	IP20	IP20	IP20	IP20

The VE6053 All Gigabit DeltaV Smart Switch

The VE6053 is an all gigabit DeltaV Smart Switch designed to be used as the central switch in a DeltaV network architecture using a star topology. In the star topology this switch would be connected to the gigabit uplink ports of a VE6046, VE6047, VE6048, or a VE6042 or VE6043 Smart Switch.

When connected to VE6041 and VE6042 Smart Switches or DeltaV controllers / CIOC / WIOC / EIOC communications will auto-negotiate to 100 Mbps.

When connected to a DeltaV workstation the communications will auto-negotiate to 1 Gbps.

This switch can be also installed in the DeltaV 2.5 network (v13.3 and newer systems only).

The VE6053 is designed to be the central switch in a star network design and should not be used as a replacement for or in place of the RM100-Series (VE6046 / VE6047 / VE6048) within the DeltaV ACN.

NOTE: For the VE6053 switch to be installed in a network the switch must be connected to a DeltaV workstation running control modules. It can be installed in the DeltaV virtualization networks only if the network is accessible to a DeltaV workstation (virtual or physical) running control modules. These control modules are required to run the DeltaV Network Device Command Center application. DeltaV Operator Workstations are not capable of running these control modules.

General Specifications for the VE6053 DeltaV Smart Switch (RM104 all Gigabit switch)



Twenty-four ports Gigabit Ethernet Industrial Workgroup switch, fan-less design Ports available: 24 ports in total; 20 10/100/1000 Mbps copper ports and four combo ports (10/100/1000 Mbps copper/RJ45 or 100/1000 Mbps SFP) – if the SFP module is installed the RJ45 port is not functional for that port.

This switch is not modular – the VE6049 expansion modules are not used on this switch.

The VE6050 transceivers can be used on this switch.

Power requirements

Operating voltage: 100 - 240 VAC, 47 - 63 Hz

Power output: 119 BTU (IT) h – without SFP transceiver modules

Power consumption: 35 W – without SFP transceiver modules

Mechanical construction

Dimensions: 448 x 345 x 44 mm (17.64 x 13.58 x 1.73 in) – without mounting bracket

Mounting: 19" control cabinet

Weight: 4.2 kg (148.15 oz)

Protection class: IP20

Interfaces

Power supply/signaling contact plug-in terminal block (max. 1 A, 24 V DC / 24 V AC)

V.24 interface RJ11 socket for serial cable connection for DeltaV Setup Wizard access USB interface for flash upgrades.

NOTES:

- Expansion modules, Fast Ethernet SFP modules, Gigabit Ethernet SFP modules and serial cable must be ordered separately.
- When rail mounted, these switches require mounting supports in addition to 10" rail mounting brackets.
- All copper ports can be connected using twisted pair cables with up to 100 meters of length.
- The built-in SFP module ports for these switches support any combination of VE6050 transceiver modules.
- This switch does not support "stacking." To create a central switch of greater than 24 ports, switches should be interconnected using any of the available . gigabit ports.

Provided in VE#

One VE6053 switch with terminal block for signal contact, two brackets with fastening screws (pre-assembled), housing feet - stick-on, and power cable.

Specifications for 100Mbps SFP Transceivers 				
LC= Connector Type MM= multi-mode SM= single mode LH=long haul	VE6050T08 M-FAST SFP-MM/LC 100 Mbps	VE6050T06 M-FAST SFP-SM/LC 100 Mbps	VE6050T05 M-FAST SFP-SM+/LC 100 Mbps	VE6050T04 M-FAST SFP-LH/LC 100 Mbps
Coupled Power max.	-14 dBm GI 62.5/125	-8 dBm	0 dBm	0 dBm
Coupled Power min.	-20 dBm GI 62.5/125	-15 dBm	-5 dBm	-5 dBm
Center Wavelength	1310 nm	1310 nm	1310 nm	1550 nm
Spectral Width (-20dB)	175 nm FWHM	7.7 nm RMS	3 nm RMS	1 nm
Low Light Threshold	-31 dBm	-28 dBm	-34 dBm	-34 dBm
Maximum Input	-14 dBm	-8 dBm	-10 dBm	-10 dBm
Loss Budget	0-11 dB GI 62.5/125 0-8 dB GI 50/125	0-13 dB	10-29 dB	10-29 dB
Maximum Link Span	0-4 km GI 62.5/125 1.0 dB/km, 500Hz·km 0-5 km GI 50/125 1.0 dB/km, 800MHz·km	0-25 km SI 9/125 0.4 dB/km	25-65 km SI 9/125	47-104 km SI 9/125 0.25 dB/km 55-140 km SI 9/125 0.18 dB/km*
<p><i>link spans with 3 dB reserve</i></p> <p>* with Corning® Ultra-Low Loss Optical Fiber <u>SMF-28</u>®</p> <p>Actual fiberoptic distances achieved greatly depend on the fiber type used and other components installed on the network such as splices and patch panels that can reduce fiberoptic signal strength.</p> <p>These modules can be used as follows:</p> <ul style="list-style-type: none"> - VE6046, VE6047, and VE6048 rack mount switch uplink SFP slots on the base module of the switch. - VE6049M04 expansion module. - VE6053 SFP slots. <p>All transceivers are compatible with both standard and extended specification switch modules.</p>				

Specifications for 1 Gbps SFP Transceivers 				
LC= connector type SX, LX, and LH indicate link distance	VE6050T07 M-SFP-SX/LC 1 Gbps	VE6050T03 M-SFP-LX/LC 1 Gbps	VE6050T02 M-SFP-LH/LC 1 Gbps	VE6050T01 M-SFP-LH+/LC 1 Gbps
Coupled Power max.	-4 dBm	-3 dBm	+5 dBm	0 dBm
Coupled Power min.	-9.5 dBm	-9.5 dBm	-2 dBm	+5 dBm
Center Wavelength	850 nm	1310 nm	1550 nm	1550 nm
Spectral Width (-20dB)	0.85 nm RMS	3 nm RMS	1 nm	1 nm
Low Light Threshold	-20 dBm	-20 dBm	-22 dBm	-30 dBm
Maximum Input	0 dBm	-3 dBm	-3 dBm	-10 dBm
Loss Budget	0–7.5 dB	0-10.5 dB	8-20 dB	15-30 dB
Maximum Link Span	0-550 m GI 50/125 3.0 dB/km, 400 MHz·km 0-275 m GI 62.5/125 3.2 dB/km, 200MHz·km	0-550 m GI 50/125 1.0 dB/km, 800 MHz·km 0-550 m GI 62,5/125 1.0 dB/km, 500 MHz·km 0-20 km SI 9/125 0.4 dB/km 2.5 dB reserve	38-68 km 0.25 dB/km	71-108 km 0.25 dB/km 71-128 km 0.21 dB/km
<p>Link spans with 3 dB reserve</p> <p>Actual fiberoptic distances achieved greatly depend on the fiber type used and other components installed on the network such as splices and patch panels that can reduce fiberoptic signal strength.</p> <p>These modules can be used as follows:</p> <ul style="list-style-type: none"> - VE6046, VE6047, and VE6048 rack mount switch in the uplink SFP slots on the base module of the switch. - VE6043 Modular DIN rail switch Gigabit uplink slots. - VE6053 switch SFP slots. <p>These modules cannot be used in the 100 Mbps slots of the VE6049M04 expansion module.</p> <p>All transceivers except the VE6050T01 are compatible with both standard and extended specification switch Modules. The VE6050T01 does not meet temperature rating of extended specification switches.</p>				

Certifications

Declaration/Approval	FP20 VE6041	FP20-ES VE6041	MD20 VE6042 MD30 VE6043	MD20-ES VE6042 MD30-ES VE6043	RM100 VE6046 VE6047 VE6048 RM104 VE6053
CE Declaration – Basic Standards EMC (Harmonized European Standards according to EMC-Directive 2004/108/EC - EN 55022 Emission of ITE - IEC/EN 61000-6-2 – Immunity in industrial environment - EN 61000-3-2 – Limits for harmonic current emissions - EN 61000-3-3 – Limitation of voltage changes, voltage fluctuations and flicker safety (Harmonized European Standards according to Low-Voltage-Directive 2006/95/EG) - EN 61131-2 – programmable controllers	Class A	Class A	Class A	Class A	Class A
FCC Declaration - CFR47 Part 15	Class A	Class A	Class A	Class A	Class A
cUL Approval according to UL 508 - UL 508 – Industrial control equipment – US. Safety standard - CSA 22.2 No. 142-M1997 – Industrial control equipment – Canadian safety standard	Yes	Yes	Yes	Yes	Yes
cUL Approval according to ISA-12.12.-01 Class 1 Div. 2 /UL1604 - ANSI/ISA 12.12.01 Approved 2001 - CSA 22.2 No. 213-M1987	Yes	Yes	Yes	Yes	N/A
IEC/EN 61131-2 Declaration - EN 61131-2 – Programmable Controllers	Yes	Yes	Yes	Yes	N/A
IEC/EN 61850-3 Declaration - EN 61850-3 – Communication Networks and Systems in Substations (environmental requirements)	Yes	Yes	Yes	Yes	N/A
cUL Approval according to UL 60950-1 - UL 60950-1 – Safety of Information Technology Equipment – US. Safety standard - CSA 22.2 No. 950 – Safety of Information Technology Equipment – Canadian safety standard	N/A	N/A	N/A	N/A	Yes
IEC/EN 60950-1 Certification according to CB-scheme* - EN 60950-1 – Information Technology Equipment – Safety	N/A	N/A	N/A	N/A	Yes
ATEX 100a Approval, Zone 2, - according to EN 60079-0 and EN 60079-15 - Electrical apparatus for explosive atmospheres	N/A	Yes	N/A	Yes	N/A
GL (Germanischer Lloyd)	Yes	Yes	Yes	Yes	N/A
C-TICK (Australia)	Yes	Yes	Yes	Yes	Yes
GOST-R (Russia)	Yes	Yes	Yes	Yes	Yes

* In order to comply with the EN 60950-1 standard (paragraph 4.3.15.5) the DeltaV Smart Switches containing laser diode emitter must also comply with the Accessible Emissions Limit for Class I when measured according to the IEC 60825-1 standard.

DeltaV Configuration Parameters







The DeltaV Smart Switches are designed to plug and play within the DeltaV network without requiring configuration of the switching functions to meet DeltaV requirements. As such all of the switching configuration parameters are preset and not user changeable. To maintain the plug and play capability of the switches user administrator access to the switch is restricted to adjusting the specific parameters listed in this table.

This table provides a list of the configuration parameters that are user accessible and can be changed using the Network Device Command Center or the Setup Wizard. All other switch configuration parameters are pre-configured and not user accessible. If the parameter is not on this list it is not accessible to be user configured.

Parameter	Description
Reset Configuration To DeltaV Defaults	Clears the information in the questions below back to DeltaV default values. This command is only available using the serial port.
Ip Address for the Switch (010.X.x.x)	Network address for the switch to enable DeltaV Smart Switch Command Center access. Entry must be in the range of permitted DeltaV addresses reserved for switches. The DeltaV Smart Switches cannot accept any IP address except those used within the DeltaV network. The subnet mask is set to 255.254.0.0 for DeltaV and is not user configurable.
Name for Switch [up to 64 Characters]	Name for switch that appears in Network Device Command Center.
Location For Switch [up to 64 Characters]	Physical location description appears in Network Device Command Center.
Disable Network Discovery	Used for setup of switches to be installed in DeltaV v10.3 or 10.3.1 only. This command disables the switch discovery access that is needed for v11 and newer systems. It should be disabled in v10 systems as a security measure.
Change Admin Password	Allows default switch admin password to be changed – only impacts access to Setup wizard. Cannot be changed through Network Device Command Center. Password can only be reset through the DeltaV Setup wizard using the serial port or telnet connection. Changing this password only impacts user access to the switch and is not connected or synchronized with the DeltaV or Windows passwords.
Change User Password	Allows default switch user password to be changed – only impacts access to Setup wizard or Web access to switch. Cannot be changed through Network Device Command Center. Password can only be reset through the DeltaV Setup wizard using the serial port or telnet connection. Changing this password only impacts user access to the switch and is not connected or synchronized with the DeltaV or Windows passwords.
Ip Address of Snmp Trap Destination Node	Allows switch to send any preconfigured traps to a computer on the DeltaV network
Ip Address of Syslog Server Node	Allows switch to send to a computer on the DeltaV network that is setup to collect communications traffic information from the switch.
Disable Telnet Access	Disable remote configuration access using Telnet.
Disable Http Access	Disable access to the view only web interface on the switch.
Time Server Ip Address	Location to get real time to sync internal clock with system - defaults to no NTS.
Backup Time Server Ip Address	Location to get real time to sync internal clock with system if primary time server is unavailable -defaults to no NTS.

Ordering Information

The specifications and DeltaV ordering numbers below provide the information necessary to help design the DeltaV network and order the necessary equipment to implement the network.



<p style="text-align: center;">VE6041 DeltaV Smart Switches <i>The modules with VE# ending in C2 are extended spec versions of the VE6041 switches and must be used where high temperature or conformal coating is required.</i></p> <p style="text-align: center;">Description</p>	<p style="text-align: center;">Model Number</p>
<p>8-ports switch – all 10/100 Mbps copper Smart 6-ports (10/100 Mbps copper) switch with two 10/100 Mbps copper uplink ports – FP20-6TX2TX Current consumption at 24 VDC 221mA Power output in BTU (IT) h 18.1</p>	 <p>VE6041F01C1 VE6041F01C2</p>
<p>8-ports switch – seven 10/100 Mbps copper and one 100 Mbps multi-mode fiber Smart 6-ports (10/100 Mbps copper) switch with two uplink Ports (one 10/100 Mbps copper and one 100 Mbps multi-mode fiber with SC connector) – FP20-6TX1MM1TX Current consumption at 24 VDC 271mA Power output in BTU (IT) h 22.2</p>	 <p>VE6041F02C1 VE6041F02C2</p>
<p>8-ports switch – seven 10/100 Mbps copper and one 100 Mbps single-mode fiber Smart 6-ports (10/100 Mbps copper) switch with two uplink ports (one 10/100 Mbps copper and one 100 Mbps single-mode fiber with SC connector) – FP20-6TX1SM1TX Current consumption at 24 VDC 271mA Power output in BTU (IT) h 22.2</p>	 <p>VE6041F03C1 VE6041F03C2</p>
<p>8-ports switch – seven 10/100 Mbps copper and one 100 Mbps long haul fiber Smart 6-ports (10/100 Mbps copper) switch with two uplink ports (one 10/100 Mbps copper and one 100 Mbps single-mode, long haul fiber with SC connector) – FP20-6TX1SMLH1TX Current consumption at 24 VDC 271mA Power output in BTU (IT) h 22.2</p>	 <p>VE6041F04C1 VE6041F04C2</p>
<p>8-ports switch – six 10/100 Mbps copper and two 100 Mbps multi-mode fiber Smart 6-ports (10/100 Mbps copper) switch with two 100 Mbps multi-mode fiber uplink ports with SC connectors – FP20-6TX2MM Current consumption at 24 VDC 321mA Power output in BTU (IT) h 26.3</p>	 <p>VE6041F05C1 VE6041F05C2</p>
<p>8-ports switch – six 10/100 Mbps copper and two 100 Mbps single-mode fiber Smart 6-ports (10/100 Mbps copper) switch with two 100 Mbps single-mode fiber uplink ports with SC connectors – FP20-6TX2SM Current consumption at 24 VDC 321mA Power output in BTU (IT) h 26.3</p>	 <p>VE6041F06C1 VE6041F06C2</p>
<p>8-ports switch – six 10/100 Mbps copper and two 100 Mbps long haul fiber Smart 6-ports (10/100 Mbps copper) switch with two 100 Mbps single-mode, long haul fiber uplink ports with SC connectors – FP20-6TX2SMLH Current consumption at 24 VDC 321mA Power output in BTU (IT) h 26.3</p>	 <p>VE6041F07C1 VE6041F07C2</p>



VE6042 and VE6043 DeltaV Smart Switches

These switches support mounting of VE6045 modules only.

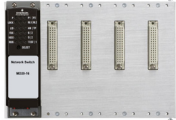
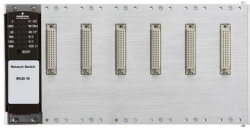
The backplane and base module are available only as a set. They cannot be purchased individually.

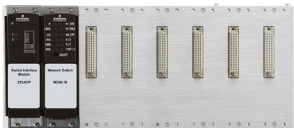
The VE6043 Gigabit uplink module is available separately—see the Spare Assembly section for details.

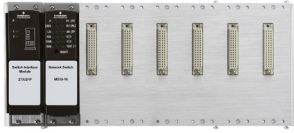
Description	Model Number
<p>8-ports switch – all 100 Mbps ports</p> <p>Smart switch for up to two VE6045-series media modules (MD20-8)</p> <p>Dimensions (W x H x D): 125 x 133 x 100 mm (4.92 x 5.24 x 3.94 in)</p> <p>Weight: 610g (21.54 oz)</p> <p>Current consumption at 24 VDC: 208 mA</p> <p>Power output in BTU (IT) h: 17.1</p> <p><i>NOTE: that the VE6042S2Cx cannot be upgraded to provide more than 8 ports. You must use the VE6042S4C1 or the VE6042S6C1 if expansion to more than 8 ports is required</i></p>	<p>VE6042S2C1 VE6042S2C2</p> 
<p>16-ports switch – all 100 Mbps ports</p> <p>Smart switch for up to four VE6045-series media modules (MD20-16)</p> <p>Dimensions (W x H x D): 202 x 133 x 100 mm (7.96 x 5.24 x 3.94 in)</p> <p>Weight: 880g (31.1 oz)</p> <p>Current consumption at 24 VDC: 500 mA</p> <p>Power output in BTU (IT) h: 41</p>	<p>VE6042S4C1 VE6042S4C2</p> 
<p>24-ports switch – all 100 Mbps ports</p> <p>Smart switch for up to six VE6045-series media modules (MD20-24)</p> <p>Dimensions (W x H x D): 278 x 133 x 100 mm (11 x 5.24 x 3.94 in)</p> <p>Weight: 1030g (36.36 oz)</p> <p>Current consumption at 24 VDC: 500 mA</p> <p>Power output in BTU (IT) h: 41</p> <p><i>NOTE: the switch may be labeled as MD20-16 but contains 6 expansion slots – this switch is built by adding the VE6044 backplane extension to a MD20-16 switch and uses the MD20-16 base module. This is really a MD20-24 switch as it has 6 expansion slots.</i></p>	<p>VE6042S6C1 VE6042S6C2</p> 
<p>10-ports switch – two 1 Gbps and eight 100 Mbps ports</p> <p>Smart switch with gigabit uplink module for up to two VE6045-series media modules</p> <p>Dimensions (W x H x D): 163 x 133 x 100 mm (6.42 x 5.24 x 3.94 in)</p> <p>Weight: 900g (31.77oz)</p> <p>Current consumption at 24 VDC: 233 mA</p> <p>Power output in BTU (IT) h: 19.1</p> <p><i>NOTE: that the VE6043S2Cx cannot be upgraded to provide more than 8 ports. You must use the VE6043S4 or S6 if expansion beyond 8 ports is required</i></p>	<p>VE6043S2C1 VE6043S2C2</p> 
<p>18-ports switch – two 1 Gbps and sixteen 100 Mbps ports</p> <p>Smart switch with gigabit uplink module for up to four VE6045-series media modules</p> <p>Dimensions (W x H x D): 240 x 133 x 100 mm (9.45 x 5.24 x 3.94 in)</p> <p>Weight: 1170g (41.30oz)</p> <p>Current consumption at 24 VDC: 525 mA</p> <p>Power output in BTU (IT) h: 43</p>	<p>VE6043S4C1 VE6043S4C2</p> 

<p>26-ports switch – two 1 Gbps and Twenty-Four 100 Mbps ports Smart switch with gigabit uplink module for up to six VE6045-series media modules (MD30-24 + MD4-2TX/SFP) Dimensions (W x H x D): 316 x 133 x 100 mm (12.44 x 5.24 x 3.94 in) Weight: 1160g (46.6oz) Current consumption at 24 VDC: 525 mA Power output in BTU (IT) h: 43</p> <p><i>NOTE: The switch may be labeled as MD30-16 but contains 6 expansion slots – this switch is built by adding the VE6044 backplane extension to a MD30-16 switch and uses the MD30-16 base module. This is really a MD30-24 switch as it has 6 expansion slots.</i></p>	<p>VE6043S6C1 VE6043S6C2</p> 
<p>Backplane Extension for VE6042S4Cx and VE6043S4Cx switches. Extension allows up to two additional media modules. Extension is compatible with extended spec devices (Cx = C1 or C2). The VE6044 cannot be used to extend the VE6042S2C1 or the VE6043S2C1, the VE6042S6Cx, or the VE6043S6Cx switches. Dimensions (W x H x D): 79 x 134 x 22 mm (3.11 x 5.26 x .87 in) Weight: 150g (5.3oz) Power consumption: 0 W Operating temperature -40°C to +70°C Conformal coated (only option available)</p>	<p>VE6044</p> 





VE6045 Media Modules for VE6042 and VE6043 DeltaV Smart Switches

<p>VE6045 media modules can be used on any of the VE6042 and VE6043 switches.</p> <p>To maintain extended specifications of the installed switch the module VE# ending C1 should not be used on the VE6042SxC2 and VE6043SxC2 extended spec switches</p> <p>The modules with VE# ending in C2 are extended spec versions of the modules and must be used where high temperature or conformal coating is required. These modules are G2 rated. The C2 modules may also be used on the standard spec version VE6042SxC1 and VE6043SxC1 switches.</p> <p><i>NOTE: Module dimensions differ in depth (either 77 or 118 mm) depending on port count and types. Cabinet depth requirements will change based on module used. When combined with switch the maximum depth required is 141 mm.</i></p>	
<p>Modules - All copper ports Model Number</p>	
<p>4-ports media module – all copper</p> <p>Smart 4-ports media module – four 10/100 Mbps copper ports (MD2-4TX1) Power consumption: 0.8 W Dimensions: 38 x 134 x 77 mm (1.50 x 5.28 x 3.03 in) Weight: 170g</p>	<p>VE6045M03C1 VE6045M03C2</p>
<p>4-ports (PoE) media module – all copper</p> <p>Smart 4-ports Power-over-Ethernet (PoE) media module – four 10/100 Mbps copper ports (MD2-4TX1-PoE) Power consumption: 0.8 W Dimensions: 38 x 134 x 77 mm (1.50 x 5.28 x 3.03 in) PoE voltage max. 60 W external 48 VDC power supply Weight: 252g</p>	<p>VE6045M11C1 VE6045M11C2</p>

Media Modules - Multi-Mode fiber ports	Model Number
<p>2-ports media module – all 100 Mbps multi-mode fiber (SC connectors) Smart 2-ports media module – two 100 Mbps multi-mode fiber ports with SC connectors (MD2-2FXM2) Power consumption: 3.4 W Dimensions: 38 x 134 x 77 mm (1.50 x 5.28 x 3.03 in) Weight: 170g</p>	<p>VE6045M01C1 VE6045M01C2</p>
<p>4-ports media module – two 10/100 Mbps copper and two 100 Mbps multi-mode fiber (SC connectors) Smart 4-ports media module – two 10/100 Mbps copper ports and two 100 Mbps multi-mode fiber ports with SC connectors (MD3-2FXM2/2TX1) Power consumption: 3.4 W Dimensions: 38 x 134 x 118 mm (1.50 x 5.28 x 4.65 in) Weight: 180g</p>	<p>VE6045M04C1 VE6045M04C2</p>
<p>4-ports media module – all 100 Mbps multi-mode fiber (SC connectors) Smart 4-ports media module – four 100 Mbps multi-mode fiber ports with SC connectors (MD3-4FX/M2) Power consumption: 7 W Dimensions: 38 x 134 x 118 mm (1.50 x 5.28 x 4.65 in) Weight: 180g</p>	<p>VE6045M06C1 VE6045M06C2</p>
<p>4-ports media module – all 100 Mbps multi-mode fiber (ST connectors) Smart 4-ports media module – four 100 Mbps multi-mode fiber ports with ST connectors (MD3-4FX/M4) Power consumption: 7 W Dimensions: 38 x 134 x 118 mm (1.50 x 5.28 x 4.65 in) Weight: 180g</p>	<p>VE6045M07C1 VE6045M07C2</p>
<p>4-ports media module – two 10/100 Mbps copper and two 100 Mbps multi-mode fiber (ST connectors) Smart 4-ports media module – two 10/100 Mbps copper ports and two 100 Mbps multi-mode fiber ports with ST connectors (MD3-2FXM4/2TX1) Power consumption: 3.4 W Dimensions: 38 x 134 x 118 mm (1.50 x 5.28 x 4.65 in) Weight: 180g</p>	<p>VE6045M09C1 VE6045M09C2</p>



Media Modules - Single-Mode fiber ports	Model Number
<p>2-ports media module – two 100 Mbps single-mode fiber (SC connectors) Smart 2-ports media module – two 100 Mbps single-mode fiber ports with SC connectors (MD2-2FXS2) Power consumption: 3.4 W Dimensions: 38 x 134 x 77 mm (1.50 x 5.28 x 3.03 in) Weight: 170g</p>	<p>VE6045M02C1 VE6045M02C2</p>
<p>4-ports media module – two 10/100 Mbps copper and two 100 Mbps single-mode fiber (SC connectors) Smart 4-ports media module – two 10/100 Mbps copper ports and two 100 Mbps single-mode fiber ports with SC connectors (MD3-2FXS2/2TX1) Power consumption: 3.4 W Dimensions: 38 x 134 x 118 mm (1.50 x 5.28 x 4.65 in) Weight: 180g</p>	<p>VE6045M05C1 VE6045M05C2</p>
<p>4-ports media module – four 100 Mbps single-mode fiber (SC connectors) Smart 4-ports media module – four 100 Mbps single-mode fiber ports with SC connectors (MD3-4FXS2) Power consumption: 7 W Dimensions: 38 x 134 x 118 mm (1.50 x 5.28 x 4.65 in) Weight: 180g</p>	<p>VE6045M08C1 VE6045M08C2</p>
<p>4-ports media module – three 10/100 Mbps copper and one 100 Mbps single-mode fiber (SC connector) Smart 4-ports media module – three 10/100 Mbps copper ports and one 100 Mbps single-mode fiber port with SC connector (MD3-1FXS2/3TX1) Power consumption: 3.4 W Dimensions: 38 x 134 x 118 mm (1.50 x 5.28 x 4.65 in) Weight: 180g</p>	<p>VE6045M10C1 VE6045M10C2</p>

Spare Assemblies for the VE6043 DeltaV Smart Switches

Description	Model Number
<p>Switch Module and Backplane for VE6043S2 Smart Switch (MD30-8) Module and backplane are not available separately and must be replaced as an assembly. KJ1611X1-DA1 = spare for the VE6043S2C1 switch KJ1611X1-DA2 = spare for the VE6043S2C2 switch</p>	<p>KJ1611X1-DA1 KJ1611X1-DA2</p> 
<p>Switch Module and Backplane for VE6043S4 and VE6043S6 Smart Switches (MD30-16) Module and backplane are not available separately and must be replaced as an assembly. KJ1611X1-DB1 = spare for the VE6043S4C1 switch KJ1611X1-DB2 = spare for the VE6043S4C2 switch</p>	<p>KJ1611X1-DB1 KJ1611X1-DB2</p> 
<p>The VE6042S6 and VE6043S6 24 port switch is not available as a spare. These switches are made by connecting a VE6044 expansion backplane to a VE6042S4Cx or a VE6043S4Cx switch. For spares order a KJ1611X1-DB1 or a KJ1611X1-DB2 and a VE6044 (or move the expansion backplane from the existing switch to the new spare switch during installation).</p>	
<p>KJ1611X1-EA1 = gigabit uplink module for the VE6043S2C1, the VE6043S4C1 and the VE6043S6C1 smart switches (MD4-2TX/SFP) KJ1611X1-EA2 = extended specification gigabit uplink module for the VE6043S2C2, the VE6043S4C2, and the VE6043S6C2 smart switches (MD4-2TX/SFP-ES)</p>	<p>KJ1611X1-EA1 KJ1611X1-EA2</p> 



VE6046 and VE6047 DeltaV Smart Switches

The VE6046 and VE6047 industrial switches are identical to the VE6048 industrial switch but have fixed amount of ports (8 or 24 copper ports). These switches should be used when a modular rack mount switch is not required. These are lower cost versions of the VE6048 and are not available with redundant power.

Description	Model Number
<p>24-ports switch – each port is 10/100 Mbps copper and it includes two 10/100/1000 Mbps copper / SFP combo uplink ports (compatible with VE6050-series transceiver modules) – RM100-24TX</p> <p>Power requirements Power output in BTU (IT) h: 55 Power consumption: 16 W Weight: 4.02Kg</p>	 <p>(This switch is not modular)</p>
Smart 24-ports switch – North American power cord	VE6046P1
Smart 24-ports switch – United Kingdom power cord	VE6046P2
Smart 24-ports switch – European power cord	VE6046P3
Smart 24-ports switch – Australian power cord	VE6046P4
<p>8-ports switch – each port is 10/100 Mbps copper and it includes two 10/100/1000 Mbps copper / SFP combo uplink ports (compatible with VE6050-series transceiver Modules) – RM100-8TX</p> <p>Power requirements Power output in BTU (IT) h: 41 Power consumption: 12 W Weight: 3.6Kg</p>	 <p>(This switch is not modular)</p>
Smart 8-ports switch – North American power cord	VE6047P1
Smart 8-ports switch – United Kingdom power cord	VE6047P2
Smart 8-ports switch – European power cord	VE6047P3
Smart 8-ports switch – Australian power cord	VE6047P4

VE6048 DeltaV Smart Switches

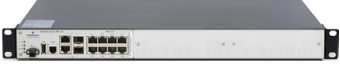



The VE6048 switch is a base chassis with eight fixed copper ports and two gigabit uplink ports. The VE6049 modules are installed to create the specific switch configuration required.

Description	Model Number
<p>8-ports switch – each port is 10/100 Mbps copper and it includes two 10/100/1000 Mbps copper / SFP combo uplink ports (compatible with VE6050-series transceiver modules). It also includes two expansion bays to add ports – RM100-Base Module</p> <p>Power requirements Power output in BTU (IT) h: 41 (without media modules) Power consumption: 12 W (without media modules) Weight: 3.60Kg (without media modules)</p>	 <p>Simplex Power Supply</p>
Smart 8-ports switch – Simplex power supply – North American power cord	VE6048R1P1
Smart 8-ports switch – Simplex power supply – United Kingdom power cord	VE6048R1P2
Smart 8-ports switch – Simplex power supply – European power cord	VE6048R1P3
Smart 8-ports switch – Simplex power supply – Australian power cord	VE6048R1P4
<p>8-ports switch – each port is 10/100 Mbps copper and it includes two 10/100/1000 Mbps copper / SFP combo uplink ports (compatible with VE6050-series transceiver modules). It also includes two expansion bays to add ports – RM100-Base Module</p> <p>Power requirements Power output in BTU (IT) h: 41 (without media modules) Power consumption: 12 W (without media modules) Weight: 3.60Kg (without media modules)</p>	 <p>Redundant Power Supplies</p>
Smart 8-ports switch – Redundant power supplies – North American power cord	VE6048R2P1
Smart 8-ports switch – Redundant power supplies – United Kingdom power cords	VE6048R2P2
Smart 8-ports switch – Redundant power supplies – European power cords	VE6048R2P3
Smart 8-ports switch – Redundant power supplies – Australian power cords	VE6048R2P4

VE6049 Expansion Modules

8-ports expansion modules for the VE6048 switch

Note: VE6049 Expansion Modules cannot be installed in the VE6046 or VE6047 switches

Description	Model Number
<p>8-ports expansion module for VE6048-series smart switches – each port is 10/100 Mbps copper (RM100-EM8TX). See specifications table below. Module is hot swappable.</p>	<p>VE6049M01</p> 
<p>8-ports expansion module for VE6048-series smart switches – each port is 100 Mbps multi-mode fiber with SC connector (RM100-EM8MMFX). See specifications table below. Module is hot swappable.</p>	<p>VE6049M02</p> 
<p>8-ports expansion module for VE6048-series smart switches – each port is 100 Mbps single-mode fiber with SC connector (RM100-EM8SMFX). See specifications table below. Module is hot swappable.</p>	<p>VE6049M03</p> 
<p>8-slots expansion module for VE6048-series smart switches – the slots can have any combination of VE6050-series 100 Mbps transceiver modules installed (RM100-EM8SFP). See specifications table below. Module and SFP transceiver modules are hot swappable.</p>	<p>VE6049M04</p> 

VE6053 DeltaV Smart Switches

The VE6053 switch is an All-Gigabit smart switch with twenty fixed copper ports and four combo ports (copper/SFP). The VE6050 transceivers can be considered to enable fiber connectivity for this switch.

Description	Model Number
<p>24-ports switch – each port is 10/100/1000 Mbps copper and it includes four 10/100/1000 Mbps copper / SFP combo ports (compatible with VE6050-series transceiver modules). Power requirements Power output in BTU (IT) h: 119 (without SFP) Power consumption: 35 W (without SFP) Weight: 4.20Kg (without SFP)</p>	 Redundant Power Supply
<p>Smart 24-ports switch – North American power cord</p>	<p>VE6053P1</p>
<p>Smart 24-ports switch – United Kingdom power cord</p>	<p>VE6053P2</p>
<p>Smart 24-ports switch – European power cord</p>	<p>VE6053P3</p>
<p>Smart 24-ports switch – Australian power cord</p>	<p>VE6053P4</p>

Fiberoptic SFP Transceivers for use in DeltaV Smart Switches

The Gigabit transceivers can be used only in the gigabit ports of the VE6046, VE6047, VE6048, VE6043, and VE6053.

The 100 Mbps transceiver modules can be used in the SFP ports of the VE6046, VE6047, VE6048, VE6053 switches, and the VE6049 SFP expansion module of the VE6048 switch.

All transceiver modules except the VE6050T01 are compatible with the extended specification switches and can also be used in the standard specification switches as well.

Power consumption for all transceiver modules: Operating voltage power supply through the switch

- Power consumption: 1 W
- Weight: 40g

NOTE: DeltaV Smart Switches must use the transceiver modules indicated below. The switches are not compatible with other brands of transceiver modules. Cisco transceiver modules are not compatible with DeltaV Smart Switches.

Description	Model Number
Transceiver module for Smart Switches: 1 Gbps Ethernet; single-mode long haul, for up to 120 Kilometers of fiberoptic cable (M-SFP-LH+/LC). <i>NOTE: This SFP Module is not compatible with extended specification usage – not available with extended temperature specifications.</i>	VE6050T01 <i>Gigabit</i> 
Transceiver module for Smart Switches: 1 Gbps Ethernet; single-mode long haul, for up to 80 Kilometers of fiberoptic cable (M-SFP-LH/LC-EEC) – extended specifications.	VE6050T02 <i>Gigabit</i> 
Transceiver module for Smart Switches: 1 Gbps Ethernet; single-mode, for up to 20 Kilometers of fiberoptic cable (M-SFP-LX/LC EEC) – extended specifications.	VE6050T03 <i>Gigabit</i> 
Transceiver module for Smart Switches: 1 Gbps Ethernet; multi-mode, for up to 550 meters of fiberoptic cable (M-SFP-SX/LC EEC) – extended specifications.	VE6050T07 <i>Gigabit</i> 
Transceiver module for Smart Switches: 100 Mbps Ethernet; single-mode, for up to 100 Kilometers of fiberoptic cable (M-FAST SFP-LH/LC-EEC) – extended specifications.	VE6050T04 
Transceiver module for Smart Switches: 100 Mbps Ethernet; single-mode, for up to 65 Kilometers of fiberoptic cable (M-FAST SFP-SM+/LC-EEC) – extended specifications.	VE6050T05 
Transceiver module for Smart Switches: 100 Mbps Ethernet; single-mode, for up to 25 Kilometers of fiberoptic cable (M-FAST SFP-SM/LC-EEC) – extended specifications.	VE6050T06 
Transceiver module for Smart Switches: 100 Mbps Ethernet; multi-mode, for up to 5 Kilometers of fiberoptic cable (M-FAST SFP-MM/LC-EEC) – extended specifications.	VE6050T08 

DeltaV Smart Switch Accessories

Description	Model Number
<p>Rack-mount kit for DIN-rail mounted Smart Switches: Allows VE6041, VE6042, and VE6043 switches to be mounted on standard 19" rails.</p> <p><i>NOTE: Switches not included. Picture shown with VE6041 switches installed.</i></p>	<p>KJ1611X1-JA1</p> 
<p>Terminal Access Cable: required to set up VE6041, VE6042, VE6043, VE6046, VE6047, VE6048, and VE6053 Smart Switches through the local serial port. One cable is compatible with all switch models.</p> <p><i>NOTES:</i></p> <ul style="list-style-type: none"> - Cable is not included with switches and must be ordered separately. - For DeltaV v11 and newer systems the KJ1611X1 Terminal Access Cable is no longer required to setup the switch. However access to the serial connection may be required to reset the switch parameters or to upgrade the switch firmware and a cable may be required. We recommend that serial cables be available on site. They must be ordered separately. One cable can access any switch – does not require a cable for each switch. Order two or three cables so extra cables are available if required. Specifications for creating your own cable are also available in DeltaV Books OnLine. 	<p>KJ1611X1-MA1</p> <p>No photo available</p>

©2016, Emerson Process Management. All rights reserved.

The Emerson logo is a trademark and service mark of Emerson Electric Company. The DeltaV logo is a mark of one of the Emerson Process Management family of companies. All other marks are the property of their respective owners.

The contents of this publication are presented for informational purposes only, and while every effort has been made to ensure their accuracy, they are not to be construed as warranties or guarantees, express or implied, regarding the products or services described herein or their use or applicability. All sales are governed by our terms and conditions, which are available on request. We reserve the right to modify or improve the design or specification of such products at any time without notice.

Emerson Process Management

Asia Pacific: 65.6777.8211
 Europe, Middle East: 41.41.768.6111
 North America, Latin America:
 T 1 (800) 833-8314 or
 1 (512) 832-3774
www.emersonprocess.com/deltav